

GV-LPC1200 1 MP 10x Zoom B/W Network Camera



- Megapixel B/W progressive scan CCD
- Motorized varifocal lens for remote focus / zoom adjustment
- Dual streams from MJPEG or H.264
- Up to 30 fps at 1280 x 720
- Maximum speed 200 km/h (124.27 mph)
- Recognition for reflective License Plate only
- Vandal resistance (IK10 for metal casing)
- Ingress protection (IP67)
- Maximum IR distance 20 m (65.6 ft)
- Built-in heater and fan
- Support for TV-out
- 10x optical zoom
- Two-way audio
- Support for I/O (2 in / 2 out)
- Defog
- Motion detection
- Text overlay
- IP address filtering
- Supports iPhone, iPad, Android & 3GPP
- ONVIF (Profile S) conformant
- 30 languages on Web interface

Introduction

GV-LPC1200 is a 1 MP B/W network camera designed for recognition of reflective license plates on vehicles traveling at 200 km/h (124.27 mph) or less. With its multiple high power LEDs and intelligent IR, the camera is able to automatically adjust its shutter speed to the scene and produce clear license plate capture for one lane under low-light conditions. The motorized varifocal lens take the advantage of its motorized focus / zoom in that the user can remotely adjust the focus and zoom through the Web interface. It is weather proof (IP67) and also able to work in environments with temperatures ranging from -40°C (-40°F) to 50°C (122°F).

Dimensions

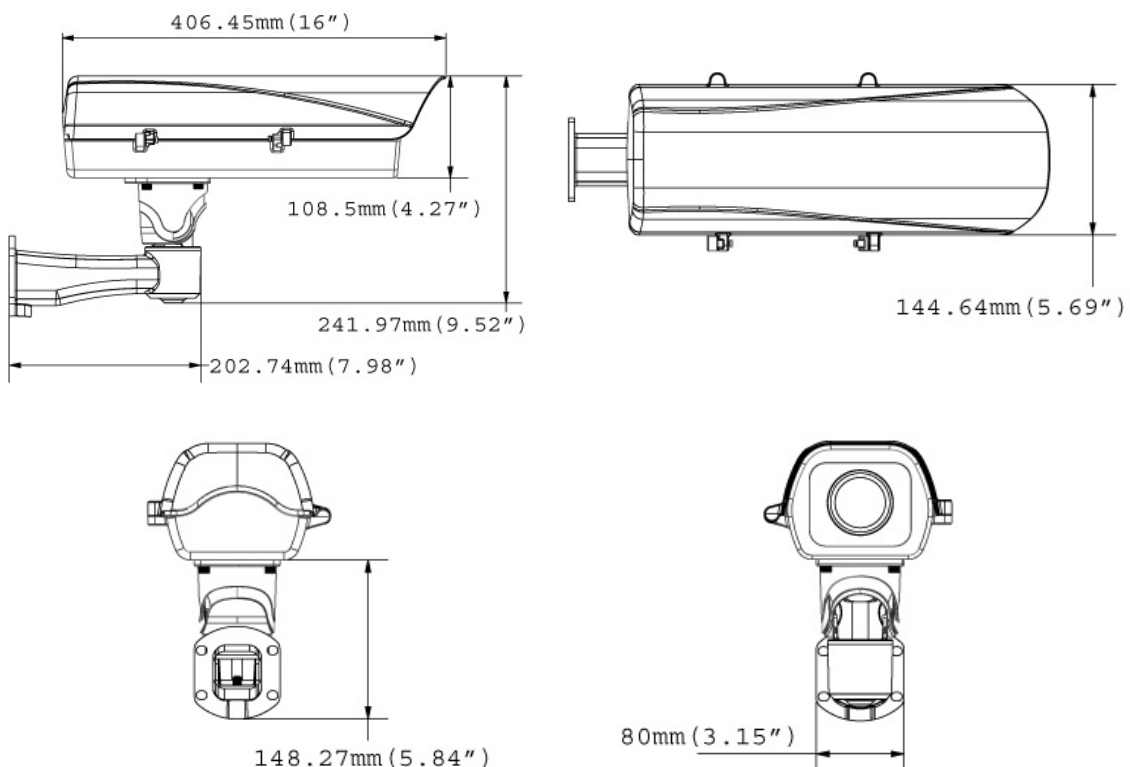

Comparison with other Outdoor GV-IP Cameras

	Headlight Turned On	High Beam Turned On
GV-LPC1200 GV-LPR1200 GV-LPC1100 GV-IP LPR Cam 5R		
GV-BL1500 Super Low Lux Bullet IP Cam		
GV-BL2400 WDR Pro Bullet IP Cam		

Note: The test results are based on the night scene. All cameras are installed at the distance of 10 m (32.81 ft) from the vehicle, with the resolution set as 1 MP or 1.3 MP and the shutter speed set as 1/2000 sec.

Specifications

Camera		
Image Sensor	Megapixel B/W progressive scan CCD	
Picture Elements	1280 (H) x 720 (V)	
Shutter Speed	Automatic: 1/1000 ~ 1/10000 sec Manual: 1/250 ~ 1/2000 sec	
S/N Ratio	52 dB	
Max. Speed	200 km/h (124.27 mph)	
Lens		
Megapixel	1 MP	
Lens Type	Motorized varifocal lens	
Focal Length	4.7 mm ~ 47 mm	
Maximum Aperture	F/3.5	
Image Format	1.3"	
Horizontal FOV	59.9° ~ 6.4°	
Operation	Focus	Auto
	Zoom	10x optical zoom
	Iris	Auto
IR LED Quantity	8 high power IR LEDs	
IR Distance	10 ~ 20 m (32.8 ~ 65.6 ft)	
Operation		
Video Compression	H.264, MJPEG	
Video Stream	Dual streams from H.264 and MJPEG	
Frame Rate	30 fps at 1280 x 720 * The frame rate and the performance may vary depending on the number of connections and data bitrates (different scenes)	
Image Setting	Brightness, Contrast, Sharpness, Gamma, Image Orientation, Shutter Speed, Defog, Maximum Video Gain	
Audio Compression	G.711, AAC (Optional)	
Audio Support	Two-way audio	
Video Resolution		
Main Stream	1280 x 720 (16:9)	
Sub Stream	640 x 360 (16:9)	
TV-Out	BNC connector (640 x 480 resolution)	
Network		
Interface	10/100/1000 Base-T Ethernet, RJ-45 connector	
Protocol	DHCP, DynDNS, FTP, HTTP, HTTPS, NTP, ONVIF (Profile S), PSIA, QoS (DSCP), RTSP, SMTP, SNMP, TCP, UDP, UPnP, 3GPP/ISMA	
Mechanical		
Temperature Detector	Yes	
Camera Adjustment	Pan	0° ~ 330°
	Tilt	0° ~ 90°
Connectors	Power	DC 12V
	Ethernet	RJ-45
	Audio	1 In (microphone jack, 3.5 mm / 0.14") 1 Out (stereo phone jack, 3.5 mm / 0.14")
	Digital I/O	2 In / 2 Out
	TV-Out	BNC connector (640 x 480 resolution)
	Mini USB	Mini USB port on the circuit board (for UMTS)
LED Indicator	N/A	
Max. Power Consumption	54 W	
Dimensions	Without support rack	406 x 145 x 109 mm (16" x 5.7" x 4.3")
Cable Length	1 m (3.28 ft)	





General		
Operating Temperature		-40°C ~ 50°C (-40°F ~ 122°F)
Humidity		10% ~ 90% (non-condensing)
Power Source		DC 12V, 5A
Max. Power Consumption		54 W
Dimensions	Without support rack	406 x 145 x 109 mm (16" x 5.7" x 4.3")
Cable Length		1 m (3.28 ft)
Weight	With support rack	3.32 kg (7.32 lb)
	Without support rack	2.62 kg (5.78 lb)
Ingress Protection		IP67
Vandal Resistance		IK10 for metal casing
Heater On		-40°C ~ 5°C (-40°F ~ 41°F)
Fan		Constantly On
Regulatory		CE, FCC, RCM, RoHS compliant
Web Interface		
Installation & Management		Web-based configuration
Firmware Upgrade		Remote upgrade through Web Browser GV-IP Device Utility included in the Software DVD
Access from Web Browser		Live View, Video Quality, Bandwidth Control, Image Snapshot, Audio, Picture in Picture, Picture and Picture, Text Overlay
Language		Arabic / Bulgarian / Czech / Danish / Dutch / English / French / German / Greek / Hebrew / Hungarian / Indonesian / Italian / Japanese / Lithuanian / Norwegian / Persian / Polish / Portuguese / Romanian / Russian / Serbian / Simplified Chinese / Slovakian / Slovenian / Spanish / Swedish / Thai / Traditional Chinese / Turkish
Applications		
Network Storage		GV-System (GV-DVR/NVR), GV-VMS, GV-Recording Server
Smart Device Access		GV-Eye for Android and iOS Embedded 3GPP/ISMA browser
Live Viewing		IE, GV-Edge Recording Manager
CMS Server support		GV-Control Center, GV-Center V2, GV-Vital Sign Monitor
LPR Management		GV-ASManager

Note: Specifications are subject to change without notice.

Packing List

- The GV-LPC1200 camera
- Screw Anchor x 4
- Screw x 4
- Washer x 4
- Torx Wrench x 1
- Power Adapter (DC 12V, 5A)
- AC Power Cord
- Silica Gel Bag x 1
- Adhesive tape for Silica Gel Bag x 1
- GV-IP LPR Camera Software CD
- GV-NVR Software DVD
- GV-ASManager Software DVD
- GV-LPR Camera Installation Guide
- Warranty Card

Accessory

Model No	Name	Details
GV-Mount300	Convex Corner Adapter Kit	 <p>Dimensions: 238.6 x 409.5 mm (9.4 x 16.1") Weight: 4.27 kg (9.41 lbs)</p>
GV-Mount310	Concave Corner Adapter Kit	 <p>Dimensions: 123.3 x 393.1 mm (4.9 x 15.5") Weight: 2.96 kg (6.53 lbs)</p>
GV-Mount400	Pole Mount Bracket Kit (Ø 4" ~ 6")	 <p>Bracket: 241 x 161 mm (9.5 x 6.3") Weight: 1.70 kg (3.75 lbs) Steel Strap Diameter: Ø 4" ~ 6"</p>
GV-Mount410	Pole Mount Bracket Kit (Ø 6" ~ 7.5")	 <p>Bracket: 241 x 161 mm (9.5 x 6.3") Weight: 1.70 kg (3.75 lbs) Steel Strap Diameter: Ø 6" ~ 7.5"</p>
GV-Relay V2		 <p>Working with the GV-Relay V2, the GV-IP LPR camera is capable of driving the loads of relay outputs over 5 volts. The GV-Relay V2 provides 4 relay outputs, and each can be set as normally open (NO) or normally closed (NC) independently as per your requirement.</p>
GV-POE Switch		The GV-POE Switch can be used for data transmission only. It does not provide power to GV-IP LPR cameras.